

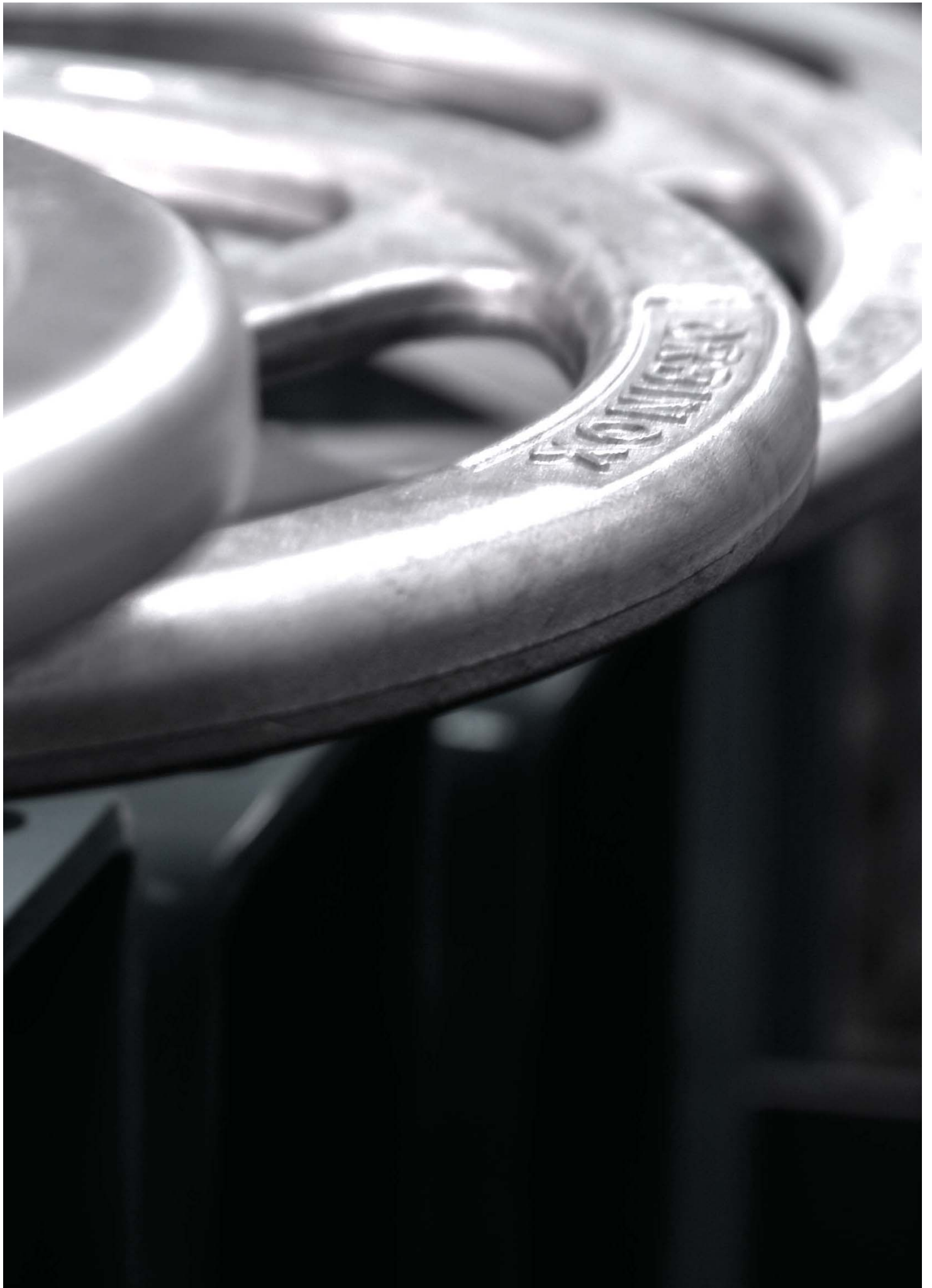

VALVE SOLUTIONS IN MORE THAN 70 COUNTRIES







45 YEARS OF EXPERIENCE AND TRUST

At ORBINOX we offer a whole range of knife gate valves, penstocks, dampers and special valves for waterworks which cover a wide variety of applications, such as wastewater treatment, pulp & paper, mining, bulk handling and other industrial processes.

Over 45 years' experience in the international market as well as the trust of our customers vouch for the success that we have achieved in design, manufacturing and distribution.

45 AÑOS DE CONFIANZA Y EXPERIENCIA

En ORBINOX ofrecemos una completa gama de válvulas de guillotina, compuertas, dampers y equipos hidromecánicos que abarca un amplio rango de aplicaciones, como el tratamiento de aguas, el manejo de sólidos, la industria papelera, la minería y otros procesos industriales.

Más de 45 años de experiencia en el mercado internacional y la confianza de nuestros clientes avalan el éxito que hemos alcanzado en el diseño, fabricación y distribución.

"Our experience generates trust in the customer"

"Nuestra experiencia genera confianza en el cliente"

Joe D'Angelo
Management - Dirección
ORBINOX CANADA





EXPERTISE AND COMMITMENT

ORBINOX has a highly qualified and experienced team providing the best solutions to suit the needs of our customers.

Our engineering department uses the latest CAD/CAM tools in order to conduct the analysis and dimensioning in 2D and 3D, as well as the Finite Elements Analysis and the use of CNC machining centres during the manufacturing process.

Product quality and customer satisfaction are our main objectives at all times.

ORBINOX maintains high standards of quality thanks to our ISO 9001:2000 assured Quality Management System. As an example every valve we produce is subjected to hydrostatic pressure tests and operational testing prior to shipping.

Offices
ORBINOX
Spain

Oficinas
ORBINOX
España



OUR TEAM NUESTRO EQUIPO

CUALIFICACIÓN Y COMPROMISO

Contamos con un equipo humano cualificado y experimentado que está capacitado para ofrecer las soluciones más adecuadas a las necesidades de nuestros clientes.

Nuestro departamento de ingeniería utiliza las últimas herramientas de CAD/CAM para realizar el análisis y dimensionamiento en 2D y 3D, así como el método de elementos finitos y la fabricación de sus válvulas en centros de mecanizado CNC.

La calidad de nuestros productos y la satisfacción del cliente son nuestra motivación en todo momento.

ORBINOX mantiene en todos sus procesos un alto grado de calidad, avalado por la certificación de su Sistema de Gestión de Calidad según ISO 9001:2000. El 100% de las válvulas son sometidas a pruebas hidrostáticas de presión y pruebas de funcionamiento antes de su envío.

"Customer satisfaction is our priority"

"Nuestra prioridad es la satisfacción de nuestros clientes"

Juanjo Herrero
Technician - Técnico
ORBINOX SPAIN





Corporate office
Oficina corporativa
Orbinox Valves International



CLOSE TO OUR CUSTOMERS

Currently, the ORBINOX group is present in over 70 countries on five continents. We have production centres in Europe, America and Asia (Spain, Canada, India and China), nine distribution companies (Canada, USA, UK, Spain, Germany, France, India, China and Indonesia) and a cutting-edge Engineering Centre in Spain.

This extensive network enables us to be close to our customers, wherever they may be, in order to offer technical advice and respond to their requirements.



IN MORE THAN 70 COUNTRIES

EN MÁS DE 70 PAÍSES

CERCA DE NUESTROS CLIENTES

En la actualidad, el grupo ORBINOX está presente en los cinco continentes, en más de 70 países; cuenta con centros de producción en Europa, América y Asia (España, Canadá, India y China), nueve empresas de distribución (Canadá, EEUU, Reino Unido, España, Alemania, Francia, India, China e Indonesia) y un vanguardista centro de ingeniería de España.

Esta extensa red permite una presencia cercana a nuestros clientes para asesorarle técnicamente y dar respuesta a sus necesidades.

“Always available to respond to your needs”

“Cerca de usted para responder a sus necesidades”



Kennis Du
Customer service - Atención al cliente
ORBINOX CHINA



- Spain
- France
- Portugal
- Italy
- Germany
- Austria
- Sweden
- Denmark
- Finland
- Norway
- Ireland
- United Kingdom
- Belgium
- Luxembourg
- Liechtenstein
- Netherlands
- Greece
- Poland
- Bulgaria
- Switzerland
- Hungary
- Lithuania
- Latvia
- Estonia
- Romania
- Slovakia
- Turkey
- Iceland
- Ukraine
- Czech Republic
- Russia
- Canada
- USA
- Mexico
- El Salvador
- Uruguay



ORBINOX CANADA



ORBINOX SPAIN

- Colombia
- Brazil
- Chile
- Peru
- Argentina
- Bolivia
- Venezuela
- Ecuador
- Egypt
- Tunisia
- Morocco
- Algeria
- South Africa
- Zambia
- Kuwait
- Qatar
- Saudi Arabia
- Jordan
- Israel
- U.A.E.
- Syria
- Iran
- Pakistan
- India
- China
- Indonesia
- Japan
- Thailand
- Malaysia
- Singapore
- Vietnam
- The Philippines
- Australia
- New Zealand
- Seychelles



ORBINOX U.K.



ORBINOX INDIA

Gate machining in
ORBINOX Anoeta

Mecanizado de
tajaderas en
ORBINOX Anoeta



QUALITY AND COMPETITIVENESS

ORBINOX offers the widest range of standard knife gate valves in the market, as well as other standard products for both water treatment and industrial applications.

Our production plants are equipped with the most up-to-date machinery as a result of a programme of continuous investment. Together with our modular product design and Production-to-order system allows us to be highly flexible with specifications and delivery dates.



STANDARD PRODUCTS

PRODUCTOS ESTÁNDAR

CALIDAD Y COMPETITIVIDAD

En ORBINOX ofrecemos la gama más completa de válvulas de guillotina estándar en el mercado así como otros productos para el tratamiento de aguas y aplicaciones industriales.

Nuestras plantas de producción están equipadas con moderna maquinaria, fruto de las continuas inversiones realizadas, que junto con nuestro diseño modular y el sistema de producción contra pedido, nos permiten conseguir una gran flexibilidad en especificaciones y plazos de entrega.

“Our flexible service allows us to adapt to individual customers”

“Nos adaptamos al cliente gracias al servicio flexible que ofrecemos”

Santhanam.P Pitchai
Quality - Calidad
ORBINOX INDIA







Special valves
assembly

Montaje de
válvulas
especiales

INNOVATION AND ADVANCED TECHNOLOGY

At ORBINOX we have always worked in cooperation with our customers to develop innovative and competitive products, providing solutions adapted to the technical challenges in different sectors and varying applications. Our dedicated R&D team works in special product development projects together with leading companies from around the world in industries such as air separation, iron and steel, water treatment and pulp & paper.



E N G I N E E R E D P R O D U C T S
P R O D U C T O S A M E D I D A

INNOVACION Y TECNOLOGIA AVANZADA

En ORBINOX hemos trabajado siempre, en cooperación con nuestros clientes, para el desarrollo de productos innovadores y competitivos, ofreciendo soluciones adaptadas a los retos técnicos que surgen en diferentes sectores y aplicaciones.

Nuestro departamento de I+D trabaja en proyectos de desarrollo de productos especiales junto con las empresas líderes de todo el mundo en los sectores de separación de aire, siderurgia, tratamiento de aguas y la industria papelera.

"We strive continuously to improve and develop our products"

"Trabajamos con el objetivo de desarrollar y mejorar el producto"

Manuel Palomeque
Engineering - Ingeniería
ORBINOX SPAIN





PRODUCTS / APPLICATIONS

PRODUCTOS / APLICACIONES

KNIFE GATE VALVES

APPLICATIONS

Pulp and Paper
Water treatment
Mining
General service (solid loaded fluids)
Bulk handling (powder, pellets...)
Food and Beverage (fishfarming,
wineries, breweries...)
Petrochemical
Power generation

SPECIAL ENGINEERED VALVES

APPLICATIONS

High pressure / size
Solid loaded / hazardous fluids
Bulk handling / abrasive services (fly ash...)

WALL AND CHANNEL PENSTOCKS / SLUICE GATES

APPLICATIONS

Water treatment
Irrigation
Desalination
Flood control
Hydropower stations

DAMPERS

APPLICATIONS

Air separation
Cement
Cogeneration systems
Power generation
Steel works

SPECIAL VALVES FOR WATERWORKS

APPLICATIONS

Outlet works of dams
Pumping stations
Hydropower stations





VÁLVULAS DE GUILLOTINA

APLICACIONES:

Pasta y papel
Tratamiento de aguas
Minería
Uso general (fluidos cargados)
Manejo de sólidos
Alimentación
(piscicultura, vino, cerveza...)
Petroquímica

VÁLVULAS ESPECIALES

APLICACIONES:

Altas presiones / Diametros grandes
Fluidos cargados / Peligrosos
Manejo de sólidos / Aplicaciones abrasivas
(cenizas...)

COMPUERTAS MURALES/CANALES

APLICACIONES:

Tratamiento de aguas
Riegos
Desalinización
Control de inundaciones
Centrales hidroeléctricas

DAMPERS

APLICACIONES:

Separación de aire
Cemento
Plantas de cogeneración
Centrales térmicas
Siderurgia

EQUIPOS HIDROMECÁNICOS

APLICACIONES:

Regulación y cierre de desagües de presas
Instalaciones de bombeo
Centrales hidroeléctricas



ORBINOX

VALVE SOLUTIONS IN MORE THAN 70 COUNTRIES

ORBINOX S.A.

Políg. Industrial s/n
20270 ANOETA - SPAIN
Tel.: +34 943 69 80 30
Fax: +34 943 65 30 66
e-mail: orbinox@orbinox.com

ORBINOX COMERCIAL

Políg. Industrial Beotibar s/n
20491 BELAUNZA - SPAIN
Tel.: +34 943 69 80 33
Fax: +34 943 65 30 22
e-mail: comercial@orbinox.com

ORBINOX VALVES INTERNATIONAL

Parque Tecnológico de San Sebastián
P^o Mikeletegi, 56-planta 3^a
20009 DONOSTIA-SAN SEBASTIÁN-SPAIN
Tel.: +34 943 69 80 30
Fax: +34 943 30 92 83
e-mail: ovi@orbinox.com

ORBINOX, CANADA

2050 Dagenais Blvd. West
H7L 5W2 LAVAL, QUEBEC
Tel. +1 450 622 87 75
Fax +1 450 622 68 31
e-mail: canada@orbinox.com

ORBINOX, USA

311 North Front Street
38821 AMORY, MISSISSIPPI
Tel. +1 662 256 2227
Fax +1 662 256 2119
e-mail: usa@orbinox.com

ORBINOX, UK

Units 6-7 Clock Park
Shripney Road - Bognor Regis
WEST SUSSEX- PO22 9NH
Tel. +44 (0) 1243 810240
Fax. +44 (0) 1243 870040
e-mail: uk@orbinox.com

ORBINOX, GERMANY

Kurzer Morgen 3
D - 58239 SCHWERTE
Tel. +49 230 49 57 05 70
Fax +49 230 49 57 05 79
e-mail: germany@orbinox.com

ORBINOX, INDIA

608/3A-2B, 608/3A-1B,
Eachanari - Chettipalayam Road,
Eachanari Post, 641021 COIMBATORE
Tel. Fax +91 (422) 2671261
e-mail: india@orbinox.com

ORBINOX, FRANCE

22, Rue Jean Rostand
69740 GENAS
Tel. +33 478 04 01 25
Fax. +33 478 04 03 56
e-mail: orbifrance-france@orange.fr

ORBINOX S.E.A.

Jl. Pilar Raya No.47, Kedoya Selatan
Jakarta Barat 11520, INDONESIA
Tel: +62 21 5835 8866
Fax: +62 21 5835 8668
e-mail: se.asia@orbinox.com

ORBINOX, CHINA

Room I, Floor 21,
ZhaoFeng Universal Building
No.1800, Zhongshan West Rd.
Xuhui District, Shanghai 200233, CHINA
Tel: +86(21)64400828 / +86(21)64400508
Fax: +86(21)64400865
e-mail: china.sales@orbinox.com

www.orbinox.com





ORBINOX

VALVE SOLUTIONS IN MORE THAN 70 COUNTRIES



PRODUCT RANGE



ORBINOX
VALVE SOLUTIONS IN MORE THAN 70 COUNTRIES



Anoeta, Spain

ORBINOX was founded in Tolosa (northern Spain) during the late 60's as a manufacturer of knife gate valves servicing the local pulp and paper industry. Recognizing that success is built on understanding customers' processes and by finding innovative solutions for difficult applications, we focused on increasing our engineering capabilities and developed many engineered valves for diverse industrial sectors. In the late 70's the company introduced the knife gate valve line in North America and other parts of the world. Today we have manufacturing plants in Spain, Canada, India and China, sales and distribution centers in the USA, UK, Germany, Spain, France, China, Canada, India, Indonesia and Brazil with agents worldwide.



ORBINOX offers a wide range of knife gate valves for handling diverse applications in the water, wastewater, bulk handling, pulp & paper and other process industries. With more than 45 years experience in the industrial market worldwide, we have become a well-known innovative knife gate manufacturer responding to new industrial developments.



Our dedicated engineering staff continues to respond to our customers' needs with new and competitive products including custom engineered valves that effectively solve problems in many industrial sectors.

Our state-of-the-art manufacturing facilities and advanced technology assures accuracy, durability, and reliability of our products, which enhances customer profitability and satisfaction. With representation covering the five continents, we are committed to the demanding critical needs of our customers who keep us in the forefront of technology. ORBINOX ensures high standards of process capability and quality endorsed by the ISO 9001 Quality Management System certification.

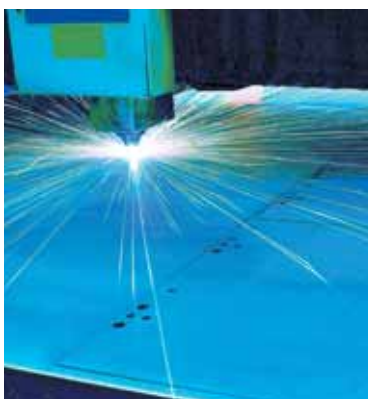



Laval, Canada



Coimbatore, India

Quality Management System For Superior Performance:

ORBINOX'S ISO 9001 certification ensures high standards of design and process capability. Thanks to our experienced and dedicated employees' participation in all fields of the organization, we continue to provide a superior quality product and a high performance service.

Our engineering department uses the latest technology of CAD software in the design stage of the product and also analyzes critical components with Finite Element Analysis software.

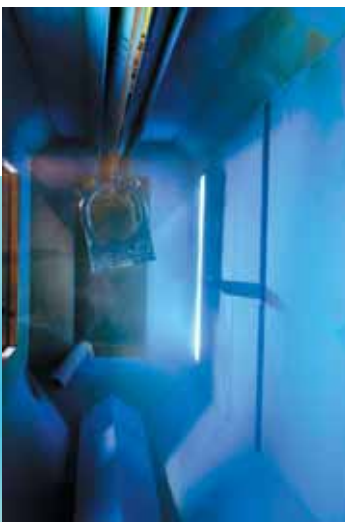

ORBINOX production plants utilize modern machining centers and automation technology enabling us to handle large production runs and customized orders. With our international manufacturing and distribution network, we offer quick access to our products worldwide.

Company Philosophy:

Our mission is to meet the needs of our customers and to continue improving our products and services through teamwork, training and performance. The company's growth is balanced on years of experience from research, design, production and marketing with a firm determination to maintain recognition of its quality and service on the market and to remain competitive in the knife gate valve industry.



KNIFE GATE VALVES

EX/EK

Wafer knife gate valve

ET

Knife gate valve
acc. to MSS SP-81

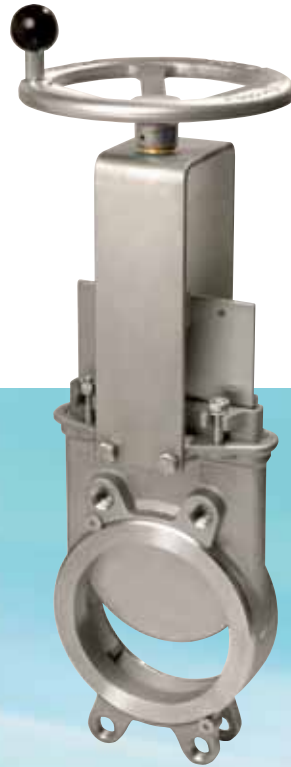

	EX/EK	ET
APPLICATION	General service (solid loaded fluids): pulp & paper, waste water, solids...	General service (solid loaded fluids): pulp & paper, waste water, solids...
SIZES	DN 50 to DN 1200 (2" to 48")	DN 50 to DN 900 (2" to 36")
WORKING PRESSURE	DN 50 - 250 (2"-10") 10 bar DN 300 - 400 (12"-16") 6 bar DN 450 (18") 5 bar DN 500 - 600 (20"-24") 4 bar DN 700 - 1200 (28"-48") 2 bar	DN 50 - DN 600 (2"-24") 10 bar (150 psi) DN 750 (30") 7 bar (100 psi) DN 900 (36") 7 bar (100 psi)
FLANGE DRILLING	PN10 ANSI 150; BST "D" Other on request	PN10 ANSI 150 Other on request



TL/TK

Through conduit knife gate valve

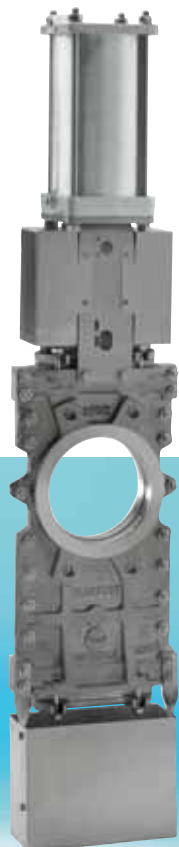

CR

Round & Square port knife gate valve



DT

Double gate knife gate valve



	TL/TK	CR	DT
APPLICATION	Solid loaded fluids (concentration > 5%): pulp, rejects, solids...	Contaminated pulp and difficult conditions (junk traps, cleaners...)	Contaminated pulp or very high concentration (pulp, rejects...)
SIZES	DN 50 to DN 1000 (2" to 40")	DN 100 to DN 600 (4" to 24")	DN 100 to DN 600 (4" to 24")
WORKING PRESSURE	DN 50-125 (2"-5") 10 bar DN 150-250 (6"-10") 8 bar DN 300-400 (12"-16") 6 bar DN 450 (18") 5 bar DN 500-600 (20"-24") 4 bar DN 700-1000 (28"-40") 2 bar	DN 100 - 400 (4"-16") 7 bar DN 500 - 600 (20"-24") 4 bar	DN 100 - 250 (4"-10") 10 bar DN 300 - 400 (12"-16") 6 bar DN 450 (18") 5 bar DN 500 - 600 (20"-24") 4 bar
FLANGE DRILLING	PN10 ANSI 150 Other on request	PN10 ANSI 150 Other on request	PN10 ANSI 150 Other on request

KNIFE GATE VALVES

EB Bi-directional
knife gate valve

VG Rubber sleeve
knife gate valve



	EB	VG
APPLICATION	General service (solid loaded fluids): waste water, sludges...	Abrasive slurries (mining, petrochemical...)
SIZES	DN 50 to DN 1200 (2" to 48")	DN 50 to DN 900 (2" to 36") Other on request
WORKING PRESSURE	Monoblock DN 50- 250 (2"-10") 10 bar DN 300 - 400 (12"-16") 6 bar DN 450 (18") 5 bar DN 500 (20") 4 bar Split body DN 600 (24") 4 bar DN 700-1200 (28"-48") 2 bar	DN 50-400 (2"-16") 10 bar (150 psi) DN 450- 600 (18"-24") 6 bar (90 psi) or 10 bar (150 psi) DN 700-900 (28"-36") 5 bar (75 psi) Other on request
FLANGE DRILLING	PN10 ANSI 150 Other on request	PN10 ANSI 150 Other on request



XC

Hopper shape
knife gate valve



BC

Square port
knife gate valve



	XC	BC
APPLICATION	Bulk handling (powder, pellets...) silo outlet applications	General service (solid loaded fluids) bulk handling
SIZES	DN 50 to DN 600 (2" to 24")	150x150 to 600x600 (other on request), (6"x 6" to 24"x24")
WORKING PRESSURE	Seat opposite pressure DN 50 - 250 (2"-10") 3 bar DN 300 - 400 (12"-16") 2 bar DN 450 (18") 1,5 bar DN 500 - 600 (20"-24") 1 bar	150x150 (6"x6") - 600x600 (24"x24") 1 bar
FLANGE DRILLING	PN10 ANSI 150 Other on request	ORBINOX Standard

ACTUATORS

Handwheel
(rising stem)



Handwheel
(non-rising stem)



Pneumatic
double-acting



Electric



Lever

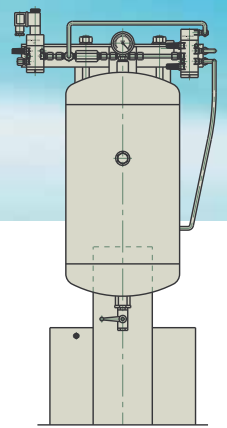
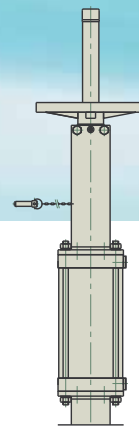
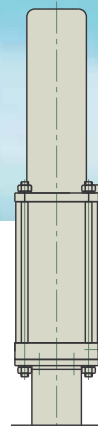
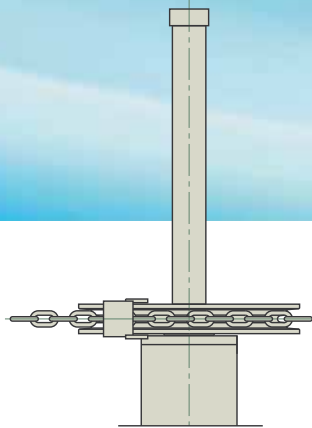
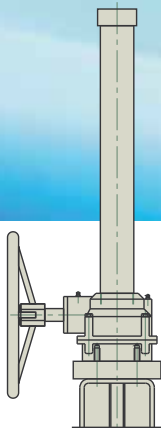
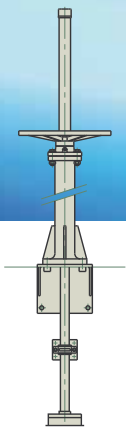

Stem extension
floorstand

Bevel gear

Chainwheel

Pneumatic single
acting

Handwheel
emergency actuator

Pneum. emergency
actuator

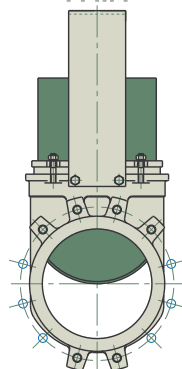

DESIGN & MATERIALS

EX/TL

EK/TK

ACCESSORIES

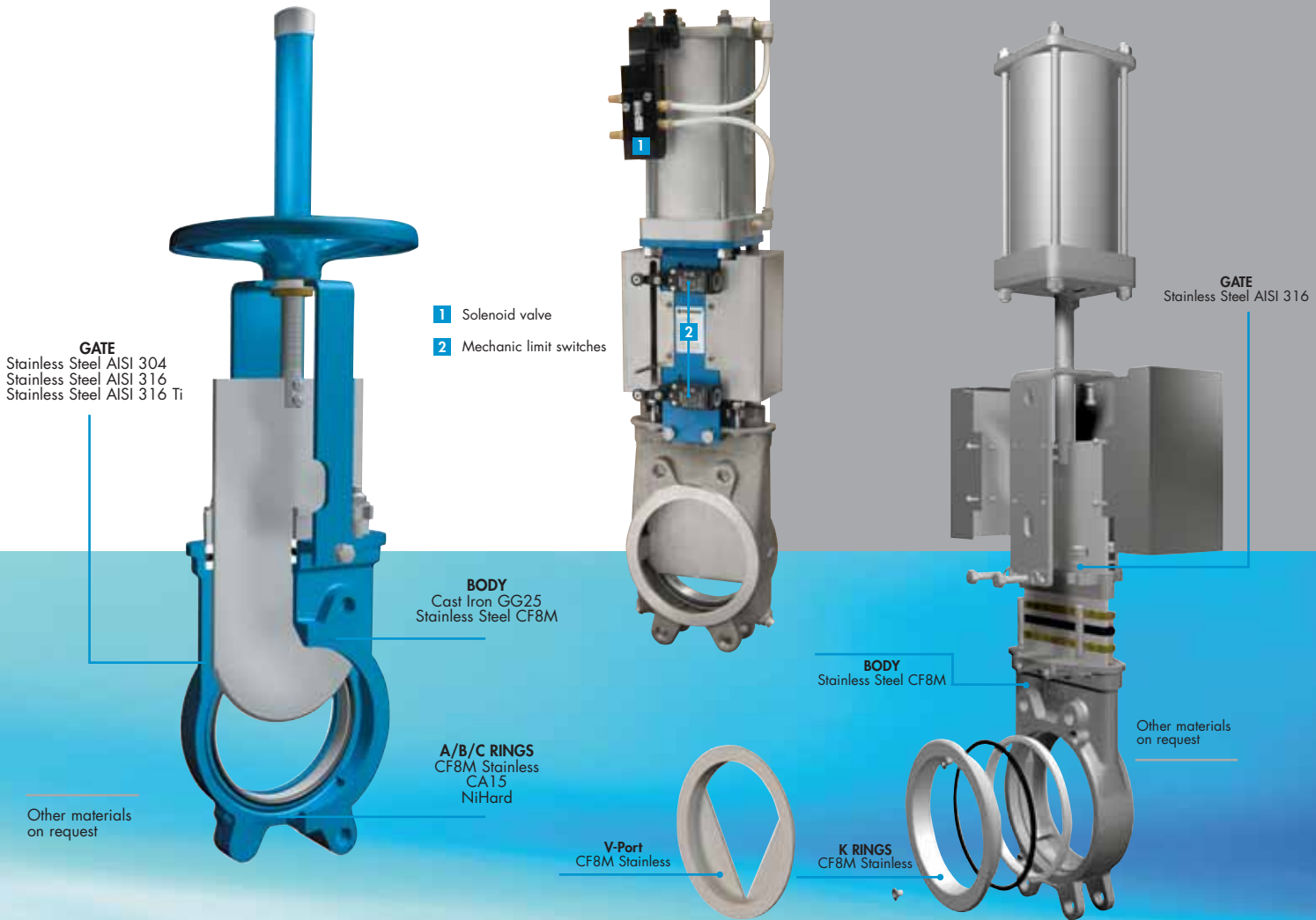

SEATING OPTIONS

EX/TL

VG

EK/TK



Metal to metal



Resilient A type (standard)

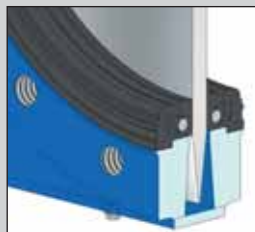

Rubber sleeves (VG)



Resilient K type



PTFE K type

EB

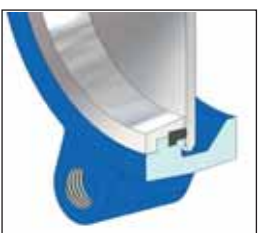

Resilient B type (reinforced)



Deflecting cone C type

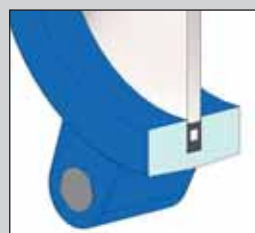

Resilient seat (EB)



Deflecting cone C type



Poliurethane seat K type

OTHER STANDARD VALVES

RM Tilting disc check valve



AT Split body knife gate valve



VP Split body bi-directional knife gate valve



TP Sampling valve



3/4V 3 / 4 way valve

KP Transmitter isolation valve

	RM	3/4V	AT	VP	TP	KP
APPLICATION	Solid loaded fluids pulp & paper, waste water	Pulp & paper	Demanding applications pulp & paper, food industry...	Demanding applications bi-directional	Pulp & paper	Transmitter isolation valve
SIZES	DN 40 to DN 900 (1 1/2" to 36")	DN 80 to DN 300 (3" to 12")	DN 50 to DN 1000 (2" to 40")	DN 50 to DN 600 (2" to 24")	DN 25/40 (1"/1" 1/2)	DN 80 (3")
WORKING PRESSURE	Up to 40 bar depending on size	10 bar	Up to 10 bar depending on size	Up to 10 bar depending on size	10 bar	10 bar



SPECIAL ENGINEERED VALVES

SD

Swing disc valve

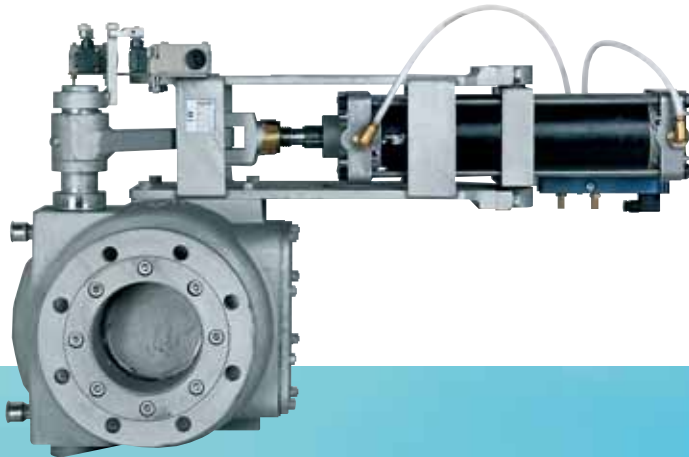

SG

Swing knife gate valve



3VY

3-way diverter valve

	SD	SG	3VY
APPLICATION	Bulk handling abrasive services (fly ash, etc.)	Bulk handling demanding applications	Bulk handling
SIZES	DN 100 to DN 300 (4" to 12")	DN 100 to DN 300 (4" to 12")	DN 50 to DN 250 (2" to 10")
WORKING PRESSURE	up to 3 bar	up to 3 bar	up to 3 bar

SPECIAL ENGINEERED VALVES

CW Single wedge knife gate valve



WS Fabricated single wedge knife gate valve

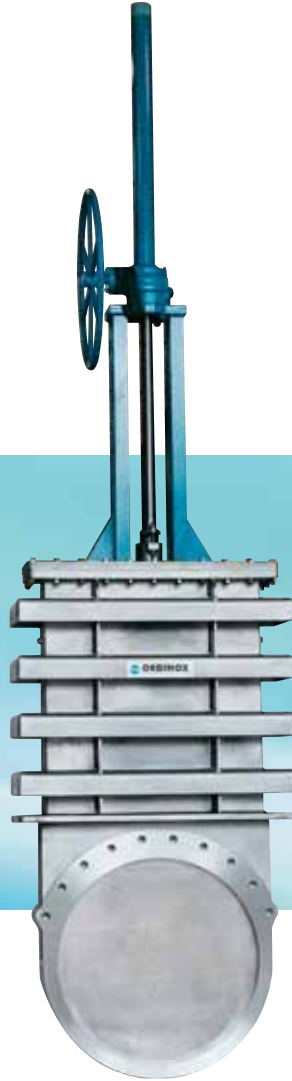

	CW	WS	BONNETED VALVES
APPLICATION	Solid loaded / hazardous fluids high pressure	Solid loaded / hazardous fluids high pressure	Solid loaded / hazardous fluids available for EX, ET, TL, XC
SIZES	DN 80 to DN 900 (3" to 36")	up to DN 2400 (96")	up to DN 600 (24")
WORKING PRESSURE	Up to 64 bar depending on size	Up to 25 bar depending on size	Up to 10 bar depending on size



WALL & CHANNEL PENSTOCKS

Wall penstocks (4 side sealing), Channel penstocks (3 side sealing), Swing check gates with round or rectangular port. Mainly used in waste water treatment plants, irrigation, hydro power stations...

Fabricated in carbon or stainless steel construction, with an elastomer sealing for bubble tight shut-off. Available in a wide range of dimensions and design pressures with either handwheel, pneumatic, electric or hydraulic actuators.

MU Wall penstock



CC Channel penstock



RR Round swing check gate



RC Rectangular swing check gate



DAMPERS

Industrial dampers for regulating, isolating or diverting (3-way) low pressure and high temperature gases for use in cogeneration systems, power plants, steel works, etc.

Fabricated in a wide variety of different materials of construction and designs (air sealing...) depending on sizes and working conditions.

Available with pneumatic, electric, hydraulic or manual actuators.

DI Multiple diverter damper

GF Goggle valve damper

ML Butterfly damper



DV Diverter damper

PE Louver damper

MP Three lever valve





VALVES FOR HYDRAULIC WORKS

ORBINOX designs and manufactures special valves and gates for regulating and closing flow through the outlet works of dams, and ducts in pumping and hydro power stations.

Rugged fabricated construction, available in a wide range of sizes and special materials to match specific requirements and depending on the head under which the valve will operate.

Available with hydraulic, electric or manual actuators.

BU

Bonneted gates



CT

Radial gates



CV

Roller gates



CH

Fixed cone valve



MB

Double eccentric butterfly valve

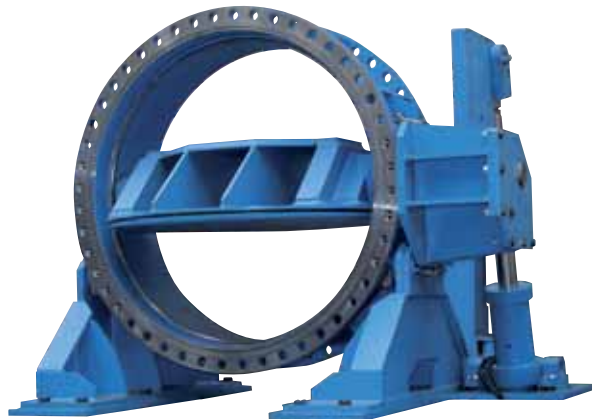



VALVE SOLUTIONS IN MORE THAN 70 COUNTRIES

ORBINOX VALVES INTERNATIONAL

Parque Tecnológico de San Sebastián
Pº Mikeletegui, 56-planta 3º
20009 DONOSTIA-SAN SEBASTIÁN-SPAIN
Tel. + 34 943 69 80 30
Fax: + 34 943 30 92 83
e-mail: ovi@orbinox.com

ORBINOX, GERMANY

Kurzer Morgen 3
D-58239 SCHWERTE
Tel. +49 230 49 57 05 70
Fax +49 230 49 57 05 79
e-mail: germany@orbinox.com

ORBINOX, CHINA

Room 1, Floor 21, ZhaoFeng Universal Building
No.1800, Zhongshan West Rd.
Xuhui District, SHANGHAI 200233, China
Tel. +86(21)64400828 / +86(21)64400508
Fax: +86(21)64400865
e-mail: china.sales@orbinox.com

ORBINOX, CANADA

2050 Dagenais Blvd. West
H7L 5W2 LAVAL, QUEBEC
Tel. +1 450 622 87 75
Fax +1 450 622 68 31
e-mail: canada@orbinox.com

ORBINOX S.A.

Pol. Industrial s/n
20270 ANOETA - SPAIN
Tel. +34 943 69 80 30
Fax +34 943 65 30 66
e-mail: orbinox@orbinox.com

ORBINOX, FRANCE

22, Rue Jean Rostand
69740 GENAS
Tel. +33 478 04 01 25
Fax. +33 478 04 03 56
e-mail: orbifrance-france@orange.fr

ORBINOX, INDIA

608/3A-2B, 608/3A-1B,
Eachanari - Chettipalayam
Road, Eachanari Post,
641021 COIMBATORE
Tel. +91 422 6691261
Fax +91 422 6691106
e-mail: india@orbinox.com

ORBINOX, USA

311 North Front Street
38821 AMORY, MISSISSIPPI
Tel. +1 662 256 2227
Fax +1 662 256 2119
e-mail: usa@orbinox.com

ORBINOX COMERCIAL

Pol. Industrial Beotibar s/n
20491 BELAUNTZA - SPAIN
Tel. +34 943 69 80 33
Fax +34 943 65 30 22
e-mail: comercial@orbinox.com

ORBINOX, UK

Units 6-7 Clock Park
Shripney Road, Bognor Regis
WEST SUSSEX-PO22 9NH
Tel. +44 (0) 1243 810240
Fax +44 (0) 1243 870040
e-mail: uk@orbinox.com

ORBINOX S.E.A

Jl. Pilar Raya No.47, Kedoya Selatan
JAKARTA BARAT 11520
INDONESIA
Tel. +62 21 5835 8866
Fax: +62 21 5835 8668
e-mail: se.asia@orbinox.com

ORBINOX, BRAZIL

Rua José del Roio 300 - Jardim
SÃO LOURENÇO / BRAGANÇA
PAULISTA / SP-CEP:12908-B44
Tel/Fax: +55 11 4035 2222
e-mail:brasil@orbinox.com

www.orbinox.com

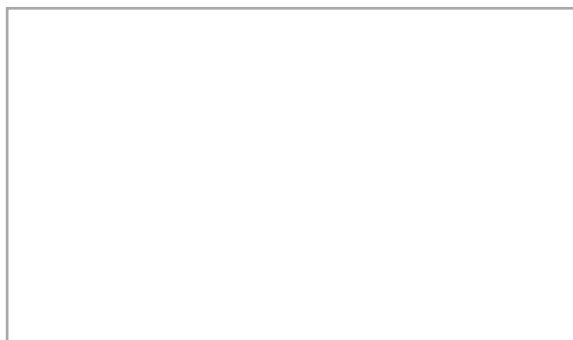

ORBINOX reserves the right to change specifications without notice.

